

**JASPER
ELECTRONICS**



CONTACT

1580 No. Kellogg Dr.
Anaheim, California, 92807

(714) 917-0749

www.jasperelectronics.com
sales@jasperelectronics.com

JBPA-C300-120 Series

Single Output 300W



JBPA SERIES FRONT VIEW

GENERAL OVERVIEW

The JBPA-C300-120 is a highly reliable cPCI Serial Power supply used for CompactPCI Serial Systems. Capable of delivering up to 300W with customer supplied 20CFM forced air cooling. With a full range input of 90- 264VAC, this power supply module achieves the highest performance and efficiency by incorporating LLC half bridge typology and synchronous rectification. The JBPA-C300 family also includes PMBus™ interface to monitor and control all essential functions of the power supply module. Custom controls available.

SPECIAL FEATURES:

- High efficiency up to 90.0%
- 300W with Customer Supplied 20 CFM Forced Air Cooling
- Active Power Factor Correction
- Wide input voltage range: 90 – 264VAC
- Redundant operation
- Hot insertion/removal (hot plug)
- Single wire current sharing
- I²C interface PMBus™ compatible for control, programming and monitoring
- Remote firmware upgrade capable
- Fully secure(OTP, OVP, OCP, SCP)
- LEDs Status: OK, Fault
- Pwr_Fail, PS ON,
- CE Compliant
- RoHS Compliant
- Three Year Warranty
- Custom modifications available

SAFETY

- UL & cUL: 62368-1, 2nd Edition
- UL & cUL: 60950-1, 2nd Edition, 2014-10-14 (Information Technology Equipment — Safety — Part 1: General Requirements)
- IEC 60950-1 (2005)(2nd Edition): Am 1:2009 + AM 2:2013
- CE Certification
- DEMKO EN 60950-1:2006/A1 1:2009, EN 60950-1:2006/A1:2010, EN 60950-1:2006/A12:2011, EN 60950-1:2006/A2:2013

APPLICATIONS

- CompactPCI Serial Systems



ISO9001:2015

American Systems
REGISTRAR

Rev A-February-6-2024

TECHNICAL SPECIFICATIONS

INPUT					
Parameter	Description/ Condition	Min	Nom	Max	Units
$V_{i\text{nom}}$	Nominal Input Voltage	100		240	VAC
V_i	Input Voltage Ranges	Normal Operating (V_{min} to V_{max})		264	VAC
$I_{i\text{max}}$	Max Input Current	$V_{\text{in}} = 90\text{VAC}/60\text{HZ}$, Full Load		4.1	A_{rms}
$I_{i\text{p}}$	Inrush Current	$264V_{\text{rms}}$, 25°C		32	A_{p}
	Leakage Current			0.3	mA
F_i	Input Frequency	47	50/60	63	Hz
PF	Power Factor	$V_{\text{in}} = 230\text{V}/50\text{Hz}$		0.96	W/VA
$V_{i\text{on}}$	Turn-On Voltage	Ramping Up		89	VAC
$V_{i\text{off}}$	Turn-Off Voltage	Ramping Down		79	VAC
Power _i	Input Power	$V_{\text{in}} = 90\text{VAC}-264\text{VAC}$		366	W
		$V_{\text{in}} = 230\text{V}$, $12\text{V}/5\text{A}$, $12\text{V}/0.5\text{A}$, $T_A = 25^\circ\text{C}$		>88	
η	Efficiency without Fan	$V_{\text{in}} = 230\text{V}$, $12\text{V}/12.5\text{A}$, $12\text{V}/1.25\text{A}$, $T_A = 25^\circ\text{C}$		>90	%
		$V_{\text{in}} = 230\text{V}$, $12\text{V}/25\text{A}$, $12\text{V}/2.5\text{A}$, $T_A = 25^\circ\text{C}$		>90	
T_{hold}	Hold-up Time	5			ms

*Specifications subject to change without notice.

1.1 INPUT FUSE

An internal 5A input fuse, in series with the input line, protects against severe defects.

1.2 INRUSH CURRENT

When the power supply module is connected to the main input, it exhibits a low and short peak current due to an X-capacitances initial charge. The internal bulk capacitor is charged through a controlled NTC circuit which will limit the inrush current.

1.3 INPUT FACTOR CORRECTION

Power factor correction (PFC) is achieved by controlling the input current waveform synchronous with the input voltage and this provides outstanding PFC results over wide input voltage and load ranges.

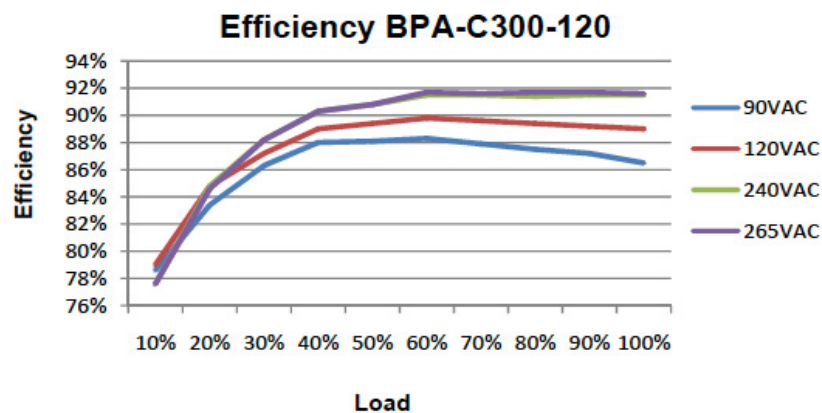

TECHNICAL SPECIFICATIONS

OUTPUT						
Parameter	Description/ Condition	Min	Nom	Max	Units	
Main Output V_1						
$V_{i\ nom}$	Nominal Output Voltage	$0.5 \cdot I_{i\ nom}, T_{amb} = 25^\circ C$		12.1	Vdc	
$V_{1\ set}$	Output Setpoint Accuracy	$0.5 \cdot I_{i\ nom}, T_{amb} = 25^\circ C$	-0.03		V_1	
$P_{1\ nom}$	Nominal Output Power	$V_1 = 12 V_{DC}$		300	W	
$I_{1\ nom}$	Nominal Output Current	$V_1 = 12 V_{DC}$		25	A_{DC}	
$V_{1\ pp}$	Output Ripple Voltage	$V_{1\ nom}, I_{1\ nom}, 20MHz\ BW, T_{amb} = 25^\circ C$		60	mV_{pp}	
$Dv_{1\ Load}$	Load Regulation	$V_i = V_{i\ nom}, 0 - 100\% I_{1\ nom}$	-1		%V	
$Dv_{1\ Line}$	Line Regulation	$V_i = V_{i\ min} \dots V_{i\ max}$	-0.5		%V	
$Dv_{1\ tot}$	Total Regulation	$V_{i\ min}$ to $V_{i\ max}, 0$ to $100\% I_{1\ nom}, T_{a\ min}$ to $T_{a\ max}$	-1		% V_1	
DI_{share}	Current Sharing	when Bus load \geq (20%)	-5		%A	
DI_{share}	Current Sharing	when Bus load $<$ (20%)	-5		%A	
Dv_{dyn}	Dynamic Load Regulation	I_{out} : 10%-50% of full load; 50--100% of full load		2	3	%V
T_{rec}	Recovery Time	$di/dt = 1A/\mu s$, recovery within 1% of $V_{1\ nom}$		600		ms
t_{ACV1}	Start-Up Time from AC	Varies with Input Line			3	sec
$tV_{1\ rise}$	Rise Time	$V_1 = 10\% \dots 90\% V_{1\ nom}$		30		ms
C_{Load}	Capacitive Loading	$T_{amb} = 25^\circ C$		36000		μF
Standby Output V_{SB}						
$V_{SB\ nom}$	Nominal Output Voltage	$0.5 \cdot I_{1\ nom}, T_{amb} = 25^\circ C$		5.0		Vdc
$V_{SB\ set}$	Output Setpoint Accuracy	$0.5 \cdot I_{1\ nom}, T_{amb} = 25^\circ C$	-1		1	V_{SB}
$P_{SB\ nom}$	Nominal Output Power	$V_{SB} = 12 V_{DC}$		12.5		W
$I_{SB\ nom}$	Nominal Output Current	$V_{SB} = 12 V_{DC}$		2.5		A_{DC}
$V_{SB\ pp}$	Output Ripple Voltage	$V_{SB}, I_{SB}, 20MHz\ BW, T_{amb} = 25^\circ C$		60		mV_{pp}
$dV_{SB\ tot}$	Total Regulation	$V_{i\ min}$ to $V_{i\ max}, 0$ to $100\% I_{1\ nom}, T_{a\ min}$ to $T_{a\ max}$	-1		1	% V_{SB}
dV_{SB}	Droop	$0 - 100\% I_{SB\ nom}$	5.2		4.8	V
$dV_{SB\ dyn}$	Dynamic Load Regulation	$\Delta I_{SB} = 50\%, I_{SB\ nom}, I_{SB\ 5} \dots 100\% I_{SB\ nom}$	-0.3		0.3	% V_{SB}
T_{rec}	Recovery Time	$di/dt = 1A/\mu s$, recovery within 1% of $V_{SB\ nom}$		200		μs
t_{ACVSB}	Start-Up Time from AC	Varies with Input Line		.7	1	sec
$tV_{SB\ rise}$	Rise Time	$V_{SB} = 10\% \dots 90\% V_{SB\ nom}$		6		ms
C_{Load}	Capacitive Loading	$T_{amb} = 25^\circ C$		10000		μF

*Specifications subject to change without notice.

2.1. OUTPUT VOLTAGE RIPPLE

Ripple and noise are measured with 0.1 μF of ceramic capacitance and 10 μF of tantalum capacitance on each of the outputs

PROTECTION					
Parameter	Description/ Condition	Min	Nom	Max	Units
F ₁	Input Fuse	Not User Accessible		5	A
V _{1OV}	Over Voltage Threshold V ₁	14.8		15.6	Vdc
t _{OVV1}	Over Voltage Latch Off Time V ₁			150	ms
V _{SB OV}	Over Voltage Threshold V _{SB}	7		8	Vsb
t _{OVVSB}	Over Voltage Latch Off Time V _{SB}			1	ms
I _{V1 lim}	Current Limit	Auto Recovery		30	A
V _{1SC Max}	Short Circuit Current V ₁	V ₁ < 3V		250	A
t _{V1 SC off}	Short Circuit Time	Time when in Short Circuit		200	us
T _{SD}	Over Temperature Protection	Internal Temperature		105	°C
	Recovery Temperature			70	°C
I _{VSB lim}	Standby Current Limit	Auto Recovery		4.5	A

*Specifications subject to change without notice.

3.1 OVERVOLTAGE PROTECTION

The power supply module will shut down if the output voltage exceeds the over voltage threshold. The power supply module must be manually repowered by recycling AC Source, by toggle PS_ON, or Pmbus™ operation command.

3.2 OVERLOAD PROTECTION

The overload protection feature will reduce the output voltage to a safe dissipation level when the output power rating exceeds 110% of a maximum rated power. The unit will automatically return to regulation upon removal of the overload.

3.3 SHORT-CIRCUIT PROTECTION

The unit will withstand a continuous short without damage. It will automatically return to regulation upon removal of the short.

3.4 OVER TEMPERATURE PROTECTION

The power supply module will shut down if temperature exceeds the over temperature threshold (internal temperature). The power supply module will restart when temperature falls below recovery temperature threshold. The power supply module can also be manually repowered by recycling AC Source, by toggle PS_ON, or Pmbus™ operation command.

SAFETY/ APPROVAL				
Parameter	Description/ Condition	Min	Max	Units
Agency Approvals	Approved to the latest edition of the following standards: UL/cUL 60950-1 IEC/EN 60950-1 UL/cUL 62368-1 IEC/EN 62368-1	Approved By independent Body		
Isolation Strength	Input(L/N) to case (PE) Input (L/N) to output Output to case (PE)	2500 4242 2500	Basic Reinforced Functional	VDC VDC VDC
Electrical Strength Test	Input to Case Input to Output	2500 4242		VDC VDC

ELECTROMAGNETIC COMPATIBILITY		
Parameter	Description/ Condition	Criterion
ESD Contact Discharge	IEC/EN61000-4-2, Level 2 ±4kV	A
Radiated Electromagnetic Field	IEC/EN61000-4-3,Level 1 (1V/m) 2.0 - 2.7GHz IEC/EN61000-4-3,Level 2 (3V/m) 80-1000MHz,1.4-2.0GHz	A A
Electrical Fast Transients/ Burst	IEC/EN61000-4-4,level 2 AC port ±1kV,1 minute	A
Surge	IEC/EN61000-4-5, Level 2 AC port 1kV,20sec CM Level 3 AC port 2kV,20sec CM	A A
RF Conducted Immunity	IEC/EN 61000-4-6,Level 2, 3 V,CW,0.15 ... 80MHz Amplitude Modulation 1kHz/80%	A
Magnetic Field Immunity	IEC/EN 61000-4-8,Level 2 3A/m	A
Voltage Dips and Interruptions	IEC/EN61000-4-11 1.0% residual voltage, 0.5 cycle 2.0% residual voltage, 1 cycle 3.40% residual voltage, 5 cycles 4.70% residual voltage, 0.5 cycle 5.70% residual voltage, 25 cycles/50Hz 6.0% residual voltage, 250 cycles/50Hz	A B B A B B

*Specifications subject to change without notice.

EMISSION		
Parameter	Description/ Condition	Criterion
Conducted Emissions	EN 55022 / EN 55016-2-1 conducted	Class B
Radiated Emission	EN 55022 / EN 55016-2-1 conducted	Class B
Harmonics Emission	IEC61000-3-2,Vin =230VAC/50Hz,100% Load	Class D
AC Flicker	IEC61000-3-3,Vin=230VAC/50Hz,100% Load,<20Arms	Pass

*Specifications subject to change without notice.

ENVIRONMENTAL					
Parameter	Description/ Condition	Min	Nom	Max	Units
T _A Ambient Temperature	V _{i min} to V _{i max,I1 nom,I5B nom}	-40		70	°C
T _S Storage Temperature	Non-Operational	-40		85	°C
Altitude	Operational, Above Sea Level		5000 16400		Meter Feet
RH Humidity	Non-Condensing	5		95	%
Shock and Vibration Acceleration	EN 61373:2010 Category 1 Class B				

*Specifications subject to change without notice.

Max ambient allowed for forced air cooling is 70°C.

Convection cooling de-rated load, 77W.

SIGNALS AND CONTROLS						
Parameter	Description/ Condition	Min	Nom	Max	Units	
<i>PS_ON/Enable</i>						
V _{IL}	Input Low Level Voltage	0		0.8	V	
V _{IH}	Input High Level Voltage	2.4		3.3	V	
R _{puPS_ON}	Internal Pull Up Resistor on PS_ON		2		kΩ	
R _{puEnable}	Internal Pull Up Resistor on Enable		2		kΩ	
<i>Pwr_Fail/PSPresent</i>						
V _{IL}	Input Low Level Voltage	0		0.8	V	
V _{IH}	Input High Level Voltage	2.4		5.3	V	
V _{IL,H}	Maximum Input Sink or Source Current	0		10	mA	
R _{puPwr_Fail}	Internal Pull Up Resistor on Pwr_Fail		1		kΩ	
<i>SCL/SDA</i>						
V _{IL}	Input Low Level Voltage	0		0.8	V	
V _{IH}	Input High Level Voltage	2.4		3.3	V	
V _{IL,H}	Maximum Input Sink or Source Current	-25		25	mA	
R _{puSCL}	Internal Pull Up Resistor on SCL		6.8		kΩ	
R _{puSDA}	Internal Pull Up Resistor on SDA		6.8		kΩ	
<i>A0/A1/A2</i>						
V _{IL}	Input Low Level Voltage	0		0.8	V	
V _{IH}	Input High Level Voltage	2.4		3.3	V	
R _{puA0}	Internal Pull Up Resistor on A0		4.7		kΩ	
R _{puA1}	Internal Pull Up Resistor on A1		4.7		kΩ	
R _{puA2}	Internal Pull Up Resistor on A2		4.7		kΩ	
<i>PSPresent</i>						
R _{puPS_Pre}	Internal Resistor to COM		100		Ω	

*Specifications subject to change without notice.

7.2 PS_ON

The PS_ON signal is used to remotely enable/disable the main output V1. This active-low pin is also used to clear any latched fault condition.

7.3 PS_PRESENT

The PS_Present signal is internally connected to COM. This active-low signal is used to indicate to a power distribution unit controller that the power supply module is fully engaged.

7.4 PWR_FAIL

The Pwr_Fail is an active-high signal that indicates whether both VSB and V1 outputs are within regulation and AC input voltage is above 80VAC. This pin is active-low when V1 and VSB are not within regulation or when the ac voltage falls outside the requirements for more than 8ms.

7.5 CURRENT SHARE (12VCS)

When used in a redundant configuration, all the current share pins need to be interconnected in order to activate the sharing function. If a supply has an internal fault or is not turned on, the current share line will automatically disengage from the bus.

If current share is not required the current share pin can be left open.

7.6 REMOTE SENSE (+VS AND -VS)

The main output incorporates sense lines to compensate for voltage drop across the load line.

1. (+) Sense connects to the positive rail of the equipment used. Maximum voltage drop of 200mV.
2. (-) Sense connects to the negative rail of the equipment used. Maximum voltage drop of 200mV.

If remote sense is not required the (+) Sense and (-) Sense pins can be left open.

FRONT LED			
Power Supply Condition	Green LED	Yellow LED	Pwr_Fail
Normal Operation	On	Off	High
Standby Mode	Blink	Off	Low
<i>PSU Faults Condition</i>			
Input UnderVoltage	Off	Blink	Low
Over Temperature	Off	On	Low
Output OverVoltage	Off	On	Low
<i>PSU Warning Condition</i>			
Over Temperature	Off	Blink	High
Input Under Voltage	Off	Blink	Low
Output OverVoltage	On	Blink	High

*Specifications subject to change without notice.

See Page 4 (3.Protections) for fault Threshold.

For Faults the power supply module must be manually repowered by recycling AC Source, by toggle PS_ON, or Pmbus™ operation command.

WARNINGS				
PSU Warning Triggers	Min	Nom	Max	Units
Over Temperature		85		°C
Input UnderVoltage		<80		VAC
Output OverVoltage		12.9		VDC

7.8 SDA & SCL

The I2C bus consist of a Serial Clock (SCL) and a Serial Data Line (SDA). Both signals lines are pull up internally to 3.3V bus via 6.8k ohm resistors, if customer requires stronger pull up resistors, it is possible to install additional pull up resistors in the customer's backplane.

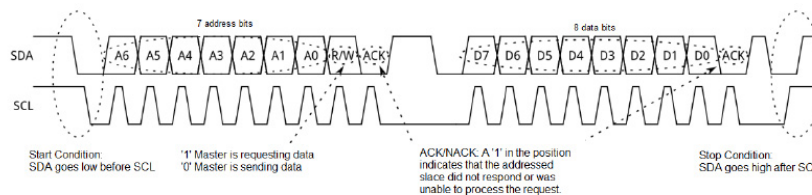

7.9 ADDRESS SELECT (A0, A1, A2)

These digital input lines are used to set the address of the power supply module. These addresses are used to differentiate between multiple power supply modules utilize in a redundant mode within the same system.

PSU ADDRESS TABLE (ADDRESS BIT SETTINGS)

A0, A1, & A2	PSU Address Value	A2	A1	A0	Recognize Address
00h	B0h	0	0	0	Yes
01h	B2h	0	0	1	Yes
02h	B4h	0	1	0	Yes
03h	B6h	0	1	1	Yes
04h	B8h	1	0	0	Yes
05h	BAh	1	0	1	Yes
06h	BCh	1	1	0	Yes
07h	BEh	1	1	1	Yes

*Specifications subject to change without notice.

PMBUS™ MONITORING

Parameter	Description/ Condition	Min	Nom	Max	Units
$V_{i\ mon}$	Input RMS Voltage $V_{i\ min} \leq V_i \leq V_{i\ max}$	-3.5		3.5	%
$I_{i\ mon}$	Input RMS Current	-2		2	%
$P_{i\ mon}$	True Input Power	-4		4	%
$V_{1\ mon}$	V1 Voltage	-0.5		0.5	%
$I_{1\ mon}$	V1 Current	-2		-2	%
$P_{o\ mon}$	Total Output Power	-1.5		-1.5	%
$V_{SB\ mon}$	Standby Voltage	-1		1	%
$I_{SB\ mon}$	Standby Current	-2		2	%
t_1	Temperature1 Ambient Inside tthe Module	-2		2	°C
t_2	Temperature2 Internal Secondary Components' Temperature	-2		2	°C

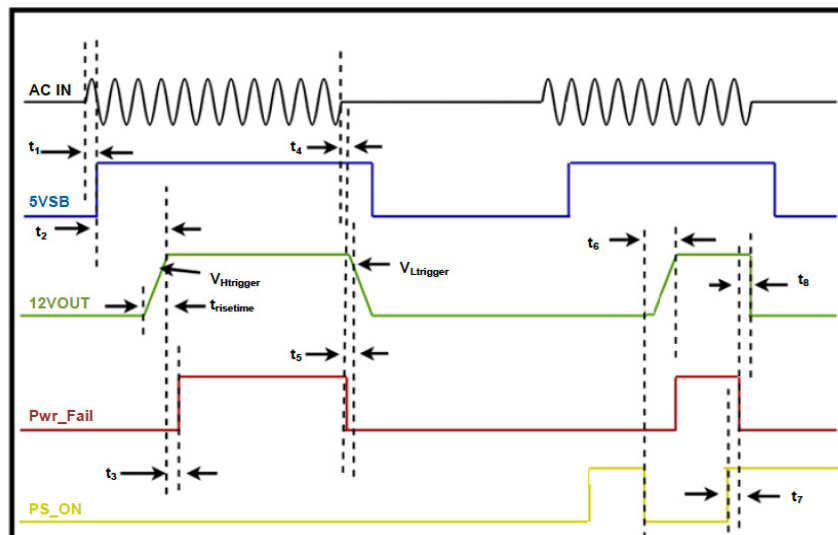

TIMING GRAPH

Parameter	Description/ Condition	Min	Nom	Max	Units	
t _r rise	12VOUT,0V to 12V	-	32	-	ms	
V _H trigger	Pwr_Fail(high)	Varies Due to Load	11.4	11.8	V	
V _L trigger	Pwr_Fail(low)	Varies Due to Load	10.8	11.4	V	
Turn-On						
t ₁	AC IN — 5 VSB	Varies Due to Line and Load	100	800	ms	
t ₂	5 VSB — 12VOUT		-	1	s	
t ₃	12VOUT — Pwr_Fail(H)		-	500	600	ms
t ₆	PS_ON(low) — 12VOUT	PS_ON Turn-ON	-	400	500	ms
Turn-Off						
t ₄	AC INPUT — Pwr_Fail	AC_IN Turn-Off	6	-	ms	
t ₅	Pwr_Fail— 12VOUT	AC_IN Turn-Off	10	-	ms	
t ₈	PS_ON(high) — Pwr_Fail	PS_ON Turn-Off	-	420	ms	
t ₇	Pwr_Fail— 12VOUT	PS_ON Turn-Off	400	-	µs	

PMBUS™ FUNCTIONALITY SUPPORTED BY PSU(PMBUS™ INFO)

Address	Commands	Description	Supported	Transaction Type	Byte_Size
00h	Page	Use to select which output gets reported via Read_VOUT, Read_IOUT & Read_POOUT commands, for PSU's with multiple outputs	Y	Read/Write	2-bytes
01h	Operation_ON_OFF	Used to enable or disable the output of the PSU depending value of the second byte that follows	Y	Read/Write	2-bytes
03h	Clear_Fault	Used to clear all status registers and error flags. This command also affects the SMB_ALERT signal	Y	Write Only	1-byte
19h	Capability	Used by the end user system to query the PSU, to determine if it supports certain features, or not. Features such packet error checking, SMB_ALERT and the max SMBUS clock rate	Y	Read Only	1-byte
79h	Status_Word	Used to retrieve and report two bytes containing a summary of faults conditions. All bits in this register should read as zero when the PSU is operating normally. This register acts as an index to all the other status registers	Y	Read/Write	2-bytes
7Ah	Status_VOut	Used to retrieve and report the status of the output voltages. It reports information such as output undervoltage, output over-voltage, output under voltage-warning	Y	Read/Write	1-byte
7Eh	Status_CML	Used to retrieve and report the status of the I2C or SMBUS communication bus; error such as packet error checking (PEC), receive an unsupported command etc...	Y	Read/Write	1-byte
88h	Read_VIN	Used to retrieve a two bytes value in Little Endian format representing the active input voltage of the device in a linear format ($VIN = Y * 2^n$), where n is the exponent in two's complement represented by the five most significant bits of the upper byte. Y is the mantissa represented the eleven lower bits of the two byte word	Y	Read Only	2-bytes
89h	Read_IIN	Used to retrieve a two bytes value in Little Endian format representing the active input current of the device in a linear format ($IIN = Y * 2^n$), where n is the exponent in two's complement represented by the five most significant bits of the upper byte. Y is the mantissa represented the eleven lower bits of the two byte word	Y	Read Only	2-bytes

PMBUS™ FUNCTIONALITY SUPPORTED BY PSU(PMBUS™ INFO)					
Address	Commands	Description	Supported	Transaction Type	Byte_Size
8Bh	Read_VOUT	Used to retrieve a two bytes value in Little Endian format representing the active output voltage of the device in a linear format ($V_{OUT} = Y \cdot 2^n$), where n is the exponent in two's compliment represented by the five most significant bits of the upper byte. Y is the mantissa represented the eleven lower bits of the two byte word	Y	Read Only	2-bytes
8Ch	Read_IOUT	Used to retrieve a two bytes value in Little Endian format representing the active output current of the device in a linear format ($I_{OUT} = Y \cdot 2^n$), where n is the exponent in two's compliment represented by the five most significant bits of the upper byte. Y is the mantissa represented the eleven lower bits of the two byte word	Y	Read Only	2-bytes
8Dh	Read_Temperature_1	Used to retrieve a two bytes value in Little Endian format representing the air intake ambient temperature of the device in a linear format ($Temp_1 = Y \cdot 2^n$), where n is the exponent in two's compliment format, represented by the five most significant bits of the upper byte. Y is the mantissa represented by the eleven lower bits of the two byte word	Y	Read Only	2-bytes
8Eh	Read_Temperature_2	Used to retrieve a two bytes value in Little Endian format representing the air exhaust ambient temperature of the device in a linear format ($Temp_2 = Y \cdot 2^n$), where n is the exponent in two's compliment format, represented by the five most significant bits of the upper byte. Y is the mantissa represented by the eleven lower bits of the two byte word	Y	Read Only	2-bytes
96h	Read_POOUT	Used to retrieve a two bytes value in Little Endian format representing the active output power of the device in a linear format ($POUT = Y \cdot 2^n$), where n is the exponent in two's compliment format, represented by the five most significant bits of the upper byte. Y is the mantissa represented by the eleven lower bits of the two byte word	Y	Read Only	2-bytes
97h	Read_PIN	Used to retrieve a two bytes value in Little Endian format representing the active input power of the device in a linear format ($PIN = Y \cdot 2^n$), where n is the exponent in two's compliment represented by the five most significant bits of the upper byte. Y is the mantissa represented by the eleven lower bits of the two byte word	Y	Read Only	2-bytes
98h	PMBUS™ - Revision	Used to set and retrieve the version of the PMBUS™ specification, with which the PSU is in compliance	Y	Read/Write	1-byte
9Ah	MFR_Model	Used to set and retrieve the manufacturer's model number assign to the device	Y	Read/Write	Variable plus 1-byte count
9Bh	MFR_Revision	Used to retrieve a two bytes value in Little Endian format representing the active input current of the device in a linear format ($IIN = Y \cdot 2^n$), where n is the exponent in two's compliment represented by the five most significant bits of the upper byte. Y is the mantissa represented the eleven lower bits of the two byte word	Y	Read/Write	1-byte
9Ch	MFR_location	Used to set and retrieve the location of manufacturing of the device	Y	Read/Write	Variable plus 1-byte count

PMBUS™ FUNCTIONALITY SUPPORTED BY PSU(PMBUS™ INFO)					
Address	Commands	Description	Supported	Transaction Type	Byte_Size
9Dh	MFR_Date	Used to set and retrieve the date of manufacturing of the device	Y	Read/Write	4-bytes plus 1-byte count
9Eh	MFR_Serial	Used to set and retrieve the value of the manufacturer's serial number assigned to the device	Y	Read/Write	Variable plus 1-byte count
A0h	MFR_VIN_MIN	Used to retrieve the value of the minimum rated input voltage that the PSU can be operated	Y	Read Only	2-bytes
A1h	MFR_VIN_MAX	Used to retrieve the value of the maximum rated input voltage that the PSU can be operated safely	Y	Read Only	2-bytes
A2h	MFR_IIN_MIN	Used to retrieve the value of the maximum rated input current in Amps, that the PSU can be operated	Y	Read Only	2-bytes
A3h	MFR_PIN_MAX	Used to retrieve the value of the maximum rated output power in Watts, that the PSU can be operated	Y	Read Only	2-bytes
A4h	MFR_VOUT_MIN	Used to retrieve the value of the minimum rated output voltage that the PSU can provide	Y	Read Only	2-bytes
A5h	MFR_VOUT_MAX	Used to retrieve the value of the maximum rated output voltage that the PSU can provide	Y	Read Only	2-bytes
A6h	MFR_IOUT_MIN	Used to retrieve the value of the maximum rated output current in Amps, that the PSU is expected to provide	Y	Read Only	2-bytes
A7h	MFR_POUT_MAX	Used to retrieve the value of the maximum rated output power in Watts, that the PSU is expected provide	Y	Read Only	2-bytes
A8h	MFR_TAMBIENT_MAX	Used to retrieve the value of the maximum ambient temperature that the PSU can be operated, in degrees Celsius	Y	Read Only	2-bytes
A9h	MFR_TAMBIENT_MIN	Used to retrieve the value of the minimum ambient temperature that the PSU can be operated, in degrees Celsius	Y	Read Only	2-bytes

8.1 CONNECTORS

Input/Output ----- FCI51939-667

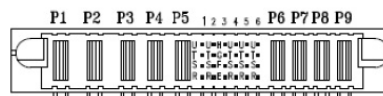

Note: H3, G3, E3 and F3 are short pins

P1	P2	P3	P4	P5	U1	U2	H3	U4	U5	U6	P6	P7	P8	P9
Line	Neutral	GND	NU	NU	NU	Pwr_Fail	PSPresent	COM	Deg	5Vstby	COM	COM	12V Out	12V Out
					T1	T2	G3	T4	T5	T6				
					NU	NU	COM	A0	5Vstby	5Vstby				
					S1	S2	F3	S4	S5	S6				
					NU	12VCS	PSON	A1	SCL	COM				
					R1	R2	E3	R4	R5	R6				
					NU	(-)VS	(+)VS	A2	SDA	Enable				

PINS	PIN TYPE	ASSIGNMENT	DESCRIPTION/ FUNCTION
Control			
E3	Signal	12VS(+)	(+) Sense - If remote sense is required this pin must be connected to the +12V load on the system backplane. This pin can be left open if remote sense is not required
R2	Signal	12VS(-)	(-) Sense - If remote sense is required this pin must be connected to the 12V return on the system backplane. This pin can be left open if remote sense is not required
S2	Signal	12VCS	Current Share - This pin must be connected to the 12V current share of the redundant power supplies on the system backplane. This pin can be left open if current share is not required
T5, T6, U6	Signal House Keeping	5VSB	5V Stand by - This is the 5V standby output voltage pin
H3	Signal	PS Present	Power Supply Present - This signal is connected to the common internally. This signal is used to identify that the power supply module is fully plugged into the system backplane
F3	Signal	PS_ON	Power Supply On - This is the power supply module control pin. This pin must be directly connected to common or controlled by a transistor connected to common on the system backplane
G3, U4, S6	Signal	COM	Common - This is the common return pin for the power supply module
U2	Signal Open Collector	Pwr_Fail	Pwr_Fail - This pin is used to monitor the output voltage. The signal on this pin will go high \approx 500mSecs after the 12V output has reached regulation (above 11.4V) and when the AC input voltage is above 88VAC. This signal will go low when the output voltage drops out of regulation (11.4V-11.8V) and when the AC input voltage drops below 88VAC. This pin must be connected to an external voltage via pull up resistor on the system backplane 20V max 10mA max
U5	Signal Open Collector	Deg	Fault/Warning - An open collector signal is provided to indicate any fault or warning for over temperature
R6	Signal	Enable	When driven high, main output is disabled. When Low, power supply main output state is as controlled by PS_ON
R5	Signal	SDA	Communication Data pin internal pulled up by a 6.8k Ω resistor
S5	Signal	SCL	Communication Clock pin internal pulled up by a 6.8k Ω resistor
T4	Signal	A0	Address Pin-This pin operates at 3.3V internal pulled up by a 4.7k Ω resistor
S4	Signal	A1	Address Pin-This pin operates at 3.3V internal pulled up by a 4.7k Ω resistor
R4	Signal	A2	Address Pin-This pin operates at 3.3V internal pulled up by a 4.7k Ω resistor.

MECHANICAL			
Parameter	Description/ Condition	Nom	Units
	Width	169.4(6.67)	
Dimension	Height	128.5(5.06)	mm(in)
	Depth	40.3(1.59)	
Weight		0.8(1.5)	Kg(lbs)

MODELS AND RATINGS

MODEL #	ASSIGNMENT	VOLTAGES	MINIMUM	MAXIMUM
JBPA-C300-120	VO1	12V	0A	25.0A
	VO2	5VSB	0A	2.5A

TECHNICAL DRAWING

Front View

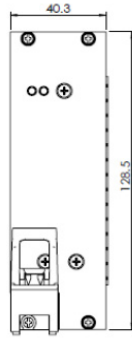

Top View

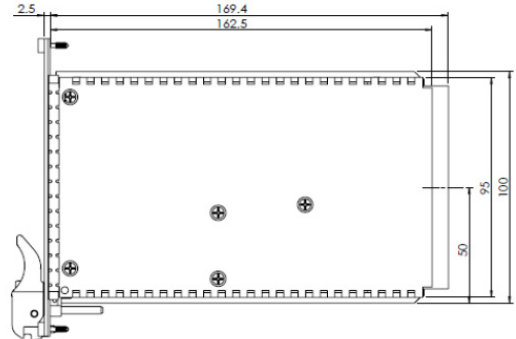

Rear View

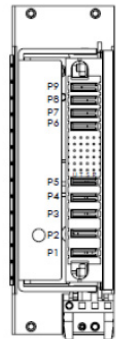

Side View

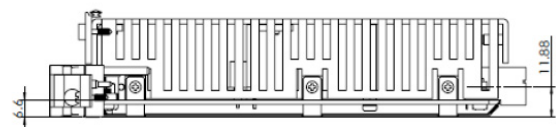

INNOVATIVE SPECIALTY DC POWER SYSTEMS

Standard and Custom Power Supplies from 5W to 10KW

TRAFFIC CONTROL POWER SUPPLIES



- 70-400+ Watts / 120 and 220 VAC Models Available
- CALTRANS TEES, NYSDOT, CDOT, GDOT Compliant for 332, 334, 336, 342, 344, and 346 Series cabinets
- RoHS and NEMA Compliant
- Custom labeling and barcoding available
- Ruggedization against shock / vibration / humidity available

CUSTOM POWER DISTRIBUTION ASSEMBLIES (PDAs)



- Compliant with TEES 2020
- 1U smaller than the PDA2-LX and PDA3-LX
- User accessible slots as specified
- Custom labeling and barcoding available
- Ruggedization against shock / vibration / humidity available

COMPACT PCI



- AC or DC input, 175W - 500W DC output, active PFC
- 3U x 8HP, 6U x 8HP sizes
- PICMG 2.11 compliant, UL/CSA, NEMKO/TUV/CE certified, ROHS compliant
- Ruggedization against shock/ vibration/ humidity optional

Primary Applications: Industrial Computing, Military, Satellite Comm, Test, Transportation, Telecom, Aerospace

SPECIALTY HOT-SWAPPABLE POWER SUPPLIES



- 200-1500W, Universal Input, 5-54VDC Output
- Hot Swap. N+1, 90+% Efficiency
- 1U Form Factors
- 30+ Variations for Various Applications Including Nuclear
- Ruggedization against shock/ vibration/ humidity optional

Primary Applications: Medical Equipment, Military, Test, Automotive, Computing, Audio, Sensitive Electronics

RACK POWER SYSTEMS



- 200W-1500W, 2-8 slots, single or mixed output voltages, up to 10KW total
- Single, dual, or individual unit AC or DC input
- Internally or externally redundant DC outputs
- Standard 19" and 23" size or user-specified configurations also available
- Ruggedization against shock/ vibration/ humidity optional

Primary Applications: Medical Equipment, Military, Test, Automotive, Computing, Audio, Sensitive Electronics

CUSTOMS & MODIFIED STANDARDS



- 75W-2KW
- Single to 7 outputs
- Designed and built to custom or semi-custom specifications
- Ruggedization against shock/ vibration/ humidity optional
- Custom electrical specs, chassis, paint, labeling, connectors, interface all available

Primary Applications: Medical Equipment, Military, Test, Automotive, Computing, Audio, Sensitive Electronics

LOW NOISE CONVECTION / CONDUCTION COOLED POWER SUPPLIES



- 200W-500W, 90—264VAC full range input with 12-54 VDC Output
- Wide operating temperature range / high efficiency
- Small form factors
- Ruggedization against shock/ vibration/ humidity optional

Primary Applications: Medical Equipment, Military, IT, Sensitive Electronics

MEDICAL ADAPTERS



- 6W-250W, Efficiency levels V & VI
- Desktop, Wall-mount, and Interchangeable AC plug types
- Large selection of output connectors – additional cable lengths available
- UL60601 (medical) approved adapters available
- Ruggedization against shock/ vibration/ humidity optional

